



SJ MEPLA Version 5.0, January 2020

The dimensioning and stress calculation of structural glass is a standard task of the daily engineering practice. Panes varying from a rectangular form, point supported glass or laminated glass can no longer be calculated by tabulations or formula but have to be evaluated by the method of the finite elements. For insulating glass units, there is hardly a possibility for calculation if any shape, any kind of fitting, laminated glass, the gas pressure law or geometrically non-linear approaches shall be considered.

This is where this program SJ MEPLA applies:

All inputs, like the geometry, the bearing conditions, the kind of loads, the calculation approach or the requested output, are guided and displayed by input masks. The control and



output of the results occurs visually in a graphics window and some calculation protocols, which can be used for the design assessment. Special new finite element methods allow the simple input and quick calculation of sandwich structures (laminated glass), so that the entire problem can be solved at shortest time (within a few minutes). Thus the program is suited for static calculations as well as also for dimensioning, for which it offers a variety of calculation possibilities:

Geometry

- Automated mesh generation for any system build from straight or curved borders only by defining the corner points
- Mesh refinement by only one element size value (The user, however, is not aware of the fact that he is working with a Finite Element Program).
- Any system shapes including cut-offs and holes are possible
- The mesh including point supports is build automatically

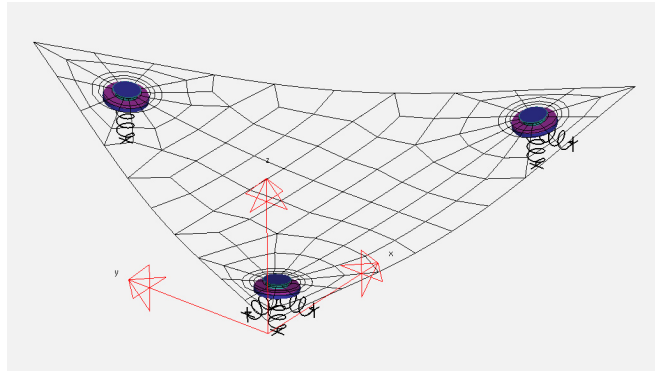

Layer

- Laminated glass considering the stiffness of the compound material PVB. The user has only to define the layer order.
- Sandwich theory is used to consider real behaviour (no approximation!)
- Any layer design up to 20 layers is possible; also for insulating glass
- Calculation of insulation glass considering the real gas pressure law
- Up to 3 gaps under any loading (climate loads like pressure differences, thermal expansion of the gas, external loads, pendulum impact,...) can be given

Boundary Conditions

- Automated generation of point fixings only by defining the position
- Eccentricities for bending effects are considered
- Properties of the point fixings can be stored in a database and can be directly chosen for insertion
- All point fixings can be calculated with contact algorithm
- Countersunk, disk or special fixings with covering layers
- Balustrade clips with circular or angular shape (usable as glass shoes for e.g. glass beams or fins)
- **(NEW V5.0)** Clamps with circular or angular shape; also toggle design clamping only the inner glass of IGU
- Bonded point fixing with no hole
- Special insulated glass fixings
- Considering the stiffness of the sub-construction or special mechanisms (e.g. a ball shaped head)
- Applying also loads or moments at point fixings
- Optional use of springs or tie bars at the point fixing
- Point supported insulating glass units
- Spacers in insulation glass (e.g. unsupported borders)
- Elastic edge or line supports including contact condition
- Elastic beams acting at the borders
- Any position of local springs with translational and rotational degrees of freedom
- Elastically bonded edges and structural glazing

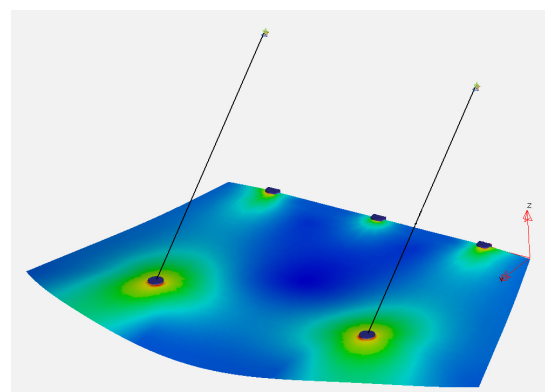
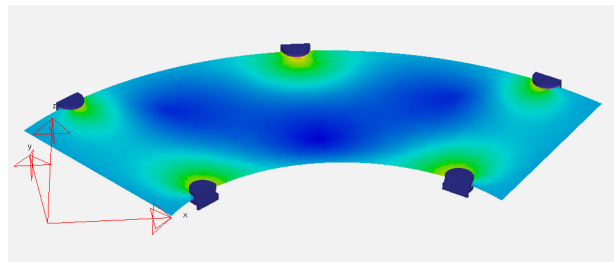

Loads

- Face loads, line loads, water pressure, dead weight
- Any point loads distributed over a definable area
- All loads can be combined
- Calculation of stresses resulting from temperature differences given for each layer
- Dynamical calculation of the pendulum impact for single-layer glass, laminated and insulation glass of any design
- The drop height of the pendulum and the impact point can be chosen freely
- Dynamically calculated pressure hits like wind blasts
- **(NEW V5.0)** New enhanced *Kelvin-Voigt* impact model including damping. This is an alternative to the pendulum body and allows also to model persons, animals or other impacts like footballs, hailstones, ...
- **(NEW V5.0)** Completely revised load case generation and stress check now according to any Codes (DIN 18008, DIN EN16612:2019, Ö-Norm, NEN2608, CAN CGSB 12.20, ...)
 - Free selectable safety and combination factors for Ultimate Limit State and Serviceability Limit State
 - The formula can be written by the customer himself for actually not included norms (a formula interpreter allows to consider any formula)
 - For each type of load now a separate k_{mod} can be given
 - Several adjustments for the way of load combination possible

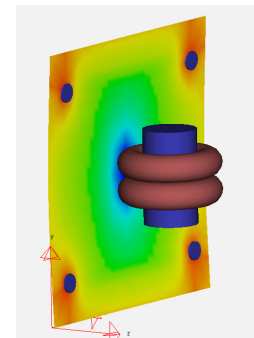
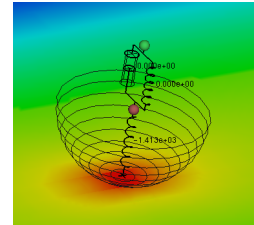
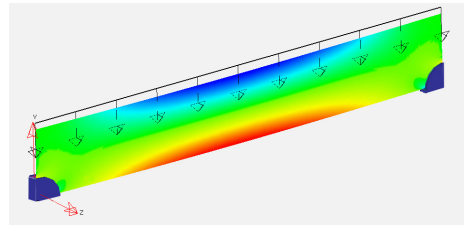

Options

- All subsequent calculations can be made linear or geometrically non-linear (large deformations)
- Special output selections like reaction forces, distance change...
- Additional output points possible for special stress and deflection results
- **(NEW V5.0)** Distance change in insulated glass as a diagram over time
- **(NEW V5.0)** Model to check remaining capacity of broken glass or the probable cracking behaviour
- Design check related to preset Code Templates
 - **(NEW V5.0)** Stress check according to user defined or preset design proof formula
 - Considering of load duration effects in resistance (k_{mod}) or other special factors
 - **(NEW V5.0)** Parallel check of free glass edges with reduced strength including bore hole rims
 - Parallel check of coated glass surfaces (enamelled)
 - **(NEW V5.0)** Proof of shortening effects now also during impact
 - **(NEW V5.0)** Applying loads in several steps now also possible together with Load Cases

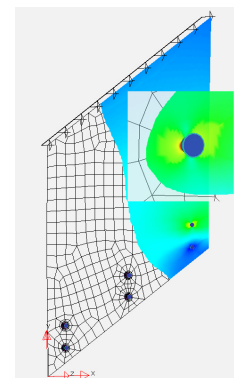
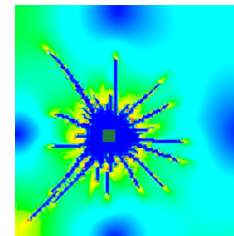

Results / Graphics

- Output of curve diagrams for forces, deformations and stresses during the impact period for any predefined position
- Printable protocol for the structural assessment including all settings, maximum stresses, deflections, reaction forces
- Multi-language protocol version (German, English, French, Dutch, Italian, Spanish, Portuguese, Polish and Czech)
- Additional protocol with load case results and resistance check
 - Tabulated condensed output
 - Open format to be used in any word processing program
 - Tabulated listing of each load case result
 - ULS and/or SLS design check
- Manifold evaluation possibilities in the post-processor
- Stresses over the plate thickness and the layer order at any point
- Display of the impactors in slow-motion
- **(NEW V5.0)** New buttons BACK, FIRST, GOTO
- **(NEW V5.0)** Displaying the *Kelvin-Voigt* impact model
- Output of all stress components
- Display of the spring reaction forces
- Vector-plot of the principal stresses
- Magnification of deformations and much more

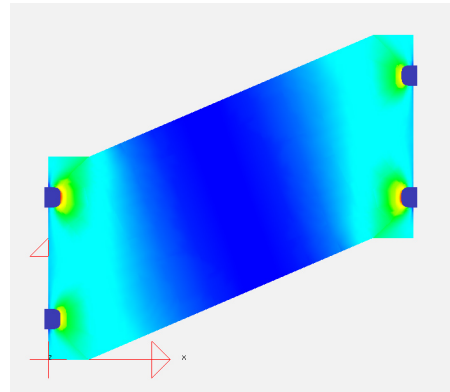

References

- See Internet <http://mepla.eu/en/references>

